



CROCHET | SKILL LEVEL: **EASY**

## ABBREVIATIONS

**Approx** = Approximately  
**Beg** = Begin(ning)  
**Ch** = Chain(s)  
**Dc** = Double crochet  
**Hdc** = Half double crochet  
**Rem** = Remain(ing)  
**Rep** = Repeat  
**Rnd(s)** = Round(s)

**RS** = Right side  
**Sc** = Single crochet  
**Sl st** = Slip stitch  
**Sp(s)** = Space(s)  
**St(s)** = Stitch(es)  
**Tog** = Together  
**WS** = Wrong side

## MEASUREMENTS

**Blanket:** Approx 16" [40.5 cm] square.

**Couch:** Approx 24" [61 cm] long x 16" [40.5 cm] deep x 12" [30.5 cm] tall.

## GAUGE

15 sc and 16 rows = 4" [10 cm] with Red Heart® Super Saver® and larger hook.

15 sc and 16 rows = 4" [10 cm] with Red Heart® Mini™ and smaller hook.

## INSTRUCTIONS

**Notes:** Ch 3 at beg of row/rnd counts as dc.

Ch 2 at beg of row/rnd **does not** count as st.

Join all rnds with sl st to top of ch 3.

**BLANKET** (make 8 Motifs each in Contrast A and B). See diagram on page 2.

With smaller hook, proceed as follows:

Ch 4. Join with sl st to first ch to form ring.

**1st rnd:** Ch 3. 2 dc in ring. Ch 2. (3 dc in ring. Ch 2) 3 times. Join.

**2nd rnd:** Sl st in each dc and next ch-2 sp. Ch 3. (2 dc. Ch 2. 3 dc) all in first ch-2 sp. [(Ch 1. 3 dc. Ch 2. 3 dc) all in next ch-2 sp] 3 times. Ch 1. Join.

**3rd rnd:** Sl st in each dc and next ch-2 sp. Ch 3. (2 dc. Ch 2. 3 dc) all in first corner ch-2 sp. Ch 1. 3 dc in next ch-1 sp. \*(Ch 1. 3 dc. Ch 2. 3 dc) all in next in corner ch-2 sp. Ch 1. 3 dc in next ch-1 sp. Rep from \* around. Join.

## MATERIALS

**Red Heart® Super Saver®** (7 oz/198 g; 364 yds/333 m)

**Main Color (MC) Orchid (0530)** **4 balls**

**Red Heart® Mini™** (1.6 oz/45 g; 72 yds/66 m)

**Contrast A Rosebud (9774)** **2 balls**

**Contrast B Spring Mix (9758)** **2 balls**

Sizes U.S. G/6 (4 mm) and U.S. 7 (4.5 mm) crochet hooks **or size needed to obtain gauge.** Stitch marker. Yarn needle. 3" [7.5 cm] thick piece of foam 11" x 24" [28 x 61 cm]. 4" [10 cm] thick piece of foam 16" x 24" [40.5 x 61 cm]. Hot glue gun and glue sticks. Quilt batting.

**4th rnd:** Sl st in each dc and next ch-2 sp. Ch 3. (2 dc. Ch 2. 3 dc) all in first corner ch-2 sp. (Ch 1. 3 dc in next ch-1 sp) twice. \*(Ch 1. 3 dc. Ch 2. 3 dc) all in next in corner ch-2 sp. (Ch 1. 3 dc in next ch-1 sp) twice. Rep from \* around. Join. Fasten off.

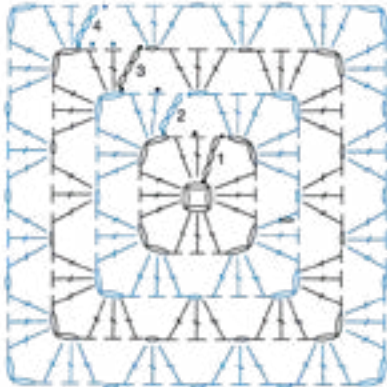

Blanket Motif

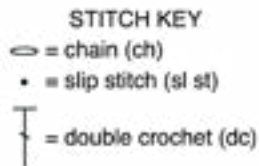

## Assembly

Sew Motifs tog into 4 Strips, with 4 Motifs in each Strip (see assembly diagram). Sew Strips tog.



**Edging:** With RS facing, join A with sl st to any corner ch-2 sp. Work 1 rnd of sc evenly around Blanket, working 3 sc in each corner. Join with sl st to first sc. Fasten off.

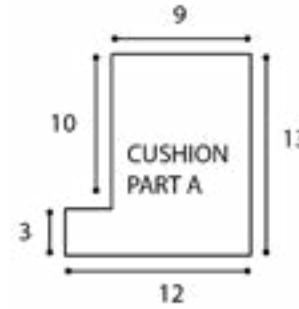

**Couch Cushions – Part A** (make 2).  
\*\*With larger hook and MC, ch 46.

**1st row:** (RS). 1 sc in 2nd ch from hook. \*1 dc in next ch. 1 sc in next ch. Rep from \* to end of chain. Turn. 45 sts.

**2nd row:** Ch 2. 1 dc in first st. \*1 sc in next st. 1 dc in next st. Rep from \* to end of row. Turn.

**3rd row:** Ch 1. 1 sc in first st. \*1 dc in next st. 1 sc in next st. Rep from \* to end of row. Turn.

Rep 2nd and 3rd rows until work from beg measures 3" [7.5 cm], ending on a WS row.\*\*

**Next row:** (RS). Sl st in each of first 12 sts. Ch 2 (**does not** count as st). 1 dc in first st. \*1 sc in next st. 1 dc in next st. Rep from \* to end of row. Turn. 33 sts.

**Next row:** Ch 1. 1 sc in first st. \*1 dc in next st. 1 sc in next st. Rep from \* to end of row. Turn.

**Next row:** Ch 2. 1 dc in first st. \*1 sc in next st. 1 dc in next st. Rep from \* to end of row. Turn.

Rep last 2 rows until work from beg measures 13" [33 cm]. Fasten off.

**Couch Cushions – Part B** (make 2).  
Work from \*\* to \*\* as given for Couch Cushions – Part A.

**Next row:** (RS). Ch 2. 1 dc in first st. \*1 sc in next st. 1 dc in next st. Rep from \* to last 12 sts. **Turn.** Leave rem sts unworked.

**Next row:** Ch 1. 1 sc in first st. \*1 dc in next st. 1 sc in next st. Rep from \* to end of row. Turn. 33 sts.

**Next row:** Ch 2. 1 dc in first st. \*1 sc in next st. 1 dc in next st. Rep from \* to end of row. Turn.

Rep last 2 rows until work from beg measures 13" [33 cm]. Fasten off.

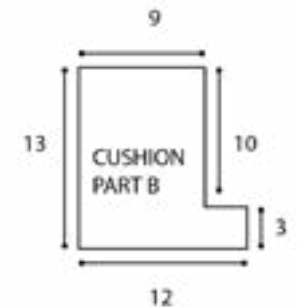

## Finishing Couch Cushions

With WS facing, place one Part A on top of one Part B piece. Work 1 rnd of sc around perimeter of pillow, working 3 sc in each corner and leaving one edge open. Cut a piece of Quilt batting to match dimensions of Cushion. Insert quilt batting into Cushion. Work one row of sc to close rem open edge. Fasten off. Rep for second cushion.

## Base of Couch

With MC and larger hook, ch 16.

**1st row:** (RS). 1 sc in 2nd ch from hook. \*1 dc in next ch. 1 sc in next ch. Rep from \* to end of chain. Turn. 15 sts.

**2nd row:** Ch 2. 1 dc in first st. \*1 sc in next st. 1 dc in next st. Rep from \* to end of row. Turn.

**3rd row:** Ch 1. 1 sc in first st. \*1 dc in next st. 1 sc in next st. Rep from \* to end of row. Turn.

Rep last 2 rows until work from beg measures 80" [203 cm], ending on a WS row. Fasten off.

## Couch Seat and Back Cushion

With MC and larger hook, ch 92.

**1st row:** (RS). 1 sc in 2nd ch from hook. \*1 dc in next ch. 1 sc in next ch. Rep from \* to end of chain. Turn.

91 sts.

**2nd row:** Ch 2. 1 dc in first st. \*1 sc in next st. 1 dc in next st. Rep from \* to end of row. Turn.

**3rd row:** Ch 1. 1 sc in first st. \*1 dc in next st. 1 sc in next st. Rep from \* to end of row. Turn.

Rep 2nd and 3rd rows until work from beg measures 3" [7.5 cm], ending on a WS row.

**Next row:** (RS). Sl st in each of first 12 sts. Ch 2 (**does not** count as st). 1 dc in first st. \*1 sc in next st. 1 dc in next st. Rep from \* to last 12 sts. Turn. Leave rem sts unworked.

**Next row:** Ch 1. 1 sc in first st. \*1 dc in next st. 1 sc in next st. Rep from \* to end of row. Turn. 67 sts.

**Next row:** Ch 2. 1 dc in first st. \*1 sc in next st. 1 dc in next st. Rep from \* to end of row. Turn.

Rep last 2 rows until work from divide row measures 16" [40.5 cm], ending on a RS row.

## Increase rows:

**1st row:** (WS). Ch 13. 1 sc in 2nd ch from hook. 1 dc in next ch. (1 sc in next ch. 1 dc in next ch) 5 times. 1 sc in first st. \*1 dc in next st. 1 sc in next st. Rep from \* to end of row. Turn.

**2nd row:** Ch 14. 1 dc in 3rd ch from

hook. 1 sc in next ch. (1 dc in next ch. 1 sc in next ch) 5 times. 1 dc in next st. \*1 sc in next st. 1 dc in next st. Rep from \* to end of row. Turn. 91 sts.

**3rd row:** Ch 1. 1 sc in first st. \*1 dc in next st. 1 sc in next st. Rep from \* to end of row. Turn.

**4th row:** Ch 2. 1 dc in first st. \*1 sc in next st. 1 dc in next st. Rep from \* to end of row. Turn.

Rep last 2 rows until work from beg measures 21" [53.5 cm], ending on a WS row. Fasten off.

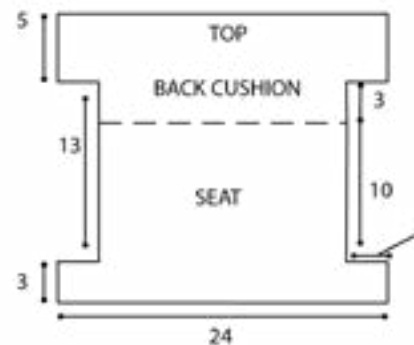

## Back of Couch

With MC and larger hook, ch 116.

**1st row:** (RS). 1 sc in 2nd ch from hook. \*1 dc in next ch. 1 sc in next ch. Rep from \* to end of chain. Turn. 115 sts.

**2nd row:** Ch 2. 1 dc in first st. \*1 sc in next st. 1 dc in next st. Rep from \* to end of row. Turn.

**3rd row:** Ch 1. 1 sc in first st. \*1 dc in next st. 1 sc in next st. Rep from \* to end of row. Turn.

Rep last 2 rows until work from beg measures 8" [20.5 cm], ending on a WS row.

**Next row:** (RS). Sl st in each of first 12 sts. Ch 2 (**does not** count as st). 1 dc in next st. \*1 sc in next st. 1 dc in next st. Rep from \* to last 12 sts. Turn. Leave rem sts unworked.

**Next row:** Ch 1. 1 sc in first st. \*1 dc in next st. 1 sc in next st. Rep from \* to end of row. Turn. 91 sts.

**Next row:** Ch 2. 1 dc in first st. \*1 sc in next st. 1 dc in next st. Rep from \* to end of row. Turn.

Rep last 2 rows until work from skipped sts measures 3" [7.5 cm]. Fasten off.

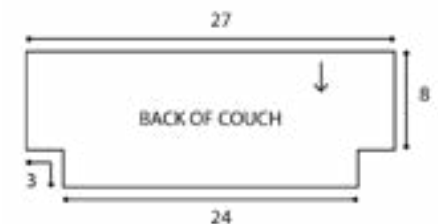

## Armrests (make 2).

With MC and larger hook, ch 38.

**1st row:** (RS). 1 sc in 2nd ch from hook. \*1 dc in next ch. 1 sc in next ch. Rep from \* to end of chain. Turn. 37 sts.

**2nd row:** Ch 2. 1 dc in first st. \*1 sc in next st. 1 dc in next st. Rep from \* to end of row. Turn.

**3rd row:** Ch 1. 1 sc in first st. \*1 dc in next st. 1 sc in next st. Rep from \* to end of row. Turn.

Rep last 2 rows until work from beg measures 9" [23 cm], ending on a WS row. Fasten off.

## Armrests Ends (make 2).

With MC and larger hook, ch 12.

**1st row:** (RS). 1 sc in 2nd ch from hook. \*1 dc in next ch. 1 sc in next ch. Rep from \* to end of chain. Turn. 11 sts.

**2nd row:** Ch 2. 1 dc in first st. \*1 sc in next st. 1 dc in next st. Rep from \* to end of row. Turn.

**3rd row:** Ch 1. 1 sc in first st. \*1 dc in next st. 1 sc in next st. Rep from \* to end of row. Turn.

Rep last 2 rows until work from beg measures 3" [7.5 cm], ending on a WS row. Fasten off.

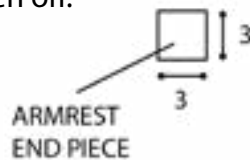

## Dust Ruffle

With MC and larger hook, ch 212.

**1st row:** (RS). 1 hdc in 3rd ch from hook. 1 hdc in each ch to end of chain. Turn. 210 sts.

**2nd row:** Ch 2. 4 dc in each st to end of row. Turn. 840 sts.

**3rd row:** Ch 1. 1 dc in each st to end of row. Fasten off.

## Bottom

With MC and larger hook, ch 92.

**1st row:** (RS). 1 sc in 2nd ch from hook. \*1 dc in next ch. 1 sc in next ch. Rep from \* to end of chain. Turn. 91 sts.

**2nd row:** Ch 2. 1 dc in first st. \*1 sc in next st. 1 dc in next st. Rep from \* to end of row. Turn.

**3rd row:** Ch 1. 1 sc in first st. \*1 dc in next st. 1 sc in next st. Rep from \* to end of row. Turn.

Rep last 2 rows until work from beg measures 16" [40.5 cm], ending on a WS row. Fasten off.

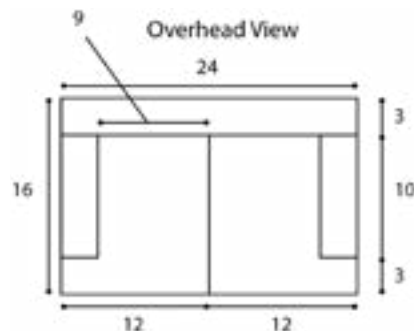

## Assembly

Sew Back section to Back Cushion and Seat as indicated in purple in diagram.

Sew Armrests to Seat as indicated in blue in diagram.

Sew corners of Back as indicated in red in diagram.

Sew Back to Back Cushion as indicated in grey in diagram.

Sew Armrest to Back Cushion and Back as indicated in orange and yellow in diagram.

Sew Armrest Ends to Armrest and seat as indicated in pink in diagram.

Sew Base to perimeter of Couch as indicated in green in diagram.

Sew Dust Ruffle to Base as shown in photo, covering front and sides.

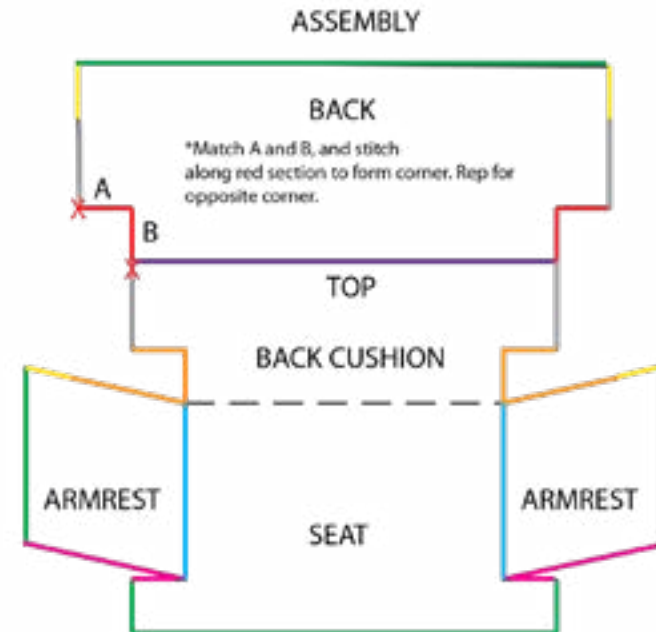

## Foam Foundation

**Note:** When cutting foam, using a serrated (bread) knife will allow greater control.

Cut the following pieces from 3" [7.5 cm] thick foam:

### Piece A: Back

One piece measuring 24" [61 cm] x 18" [45.5].

### Pieces B and C: Armrests

Two pieces measuring 3" [7.5 cm] x 10" [25.5 cm].

Using hot glue gun, assemble pieces on 4" [10 cm] slab of foam (D) measuring 16" [40.5 cm] x 24" [61 cm] as shown in diagram. Affix assembled Couch Cover to foam foundation. Tack with yarn and yarn needle or hot glue if needed to secure cover. Sew Bottom to lower edge of Base.

